

SOPHOS

Operating Instructions

APX 320X



Foreward

We are pleased to welcome you as a new Sophos APX Series customer.

Sophos APX Series access points are high performance wireless products using the latest 802.11ac Wave 2 technology for a best-in-class user experience. The APX Series models can be easily managed in Sophos Central, our cloud-based security management platform. All you need to do is set up a Sophos Central account and plug in the device anywhere in your network. The access point will find the cloud-based controller automatically and become operable within seconds.

These operating instructions will help you set up your Sophos Central account, install and configure your Sophos APX Series access point and also provide detailed technical specifications. In addition, please also see the following documents that contain useful information on safety, regulatory compliance, and configuration options:

- Sophos APX Series Safety Instructions and Regulatory Information
- Sophos APX 320X Quick Start Guide

The instructions must be read carefully prior to using the device and should be kept in a safe place. You can download all user manuals and additional documentation from the Sophos Knowledgebase under www.sophos.com/en-us/support/knowledgebase.aspx or from www.sophos.com/get-started-ap.



Security symbols

The following symbol and its meaning appears in the Quick Start Guide, Safety Instructions and in these Operating Instructions.

Caution and Important Note. If these notes are not correctly observed:

- This is dangerous to life and the environment
- The access point may be damaged
- The functions of the access point will be no longer guaranteed
- Sophos shall not be liable for damages arising from a failure to comply with the Safety Instructions

Designed use

The access point must be installed pursuant to the current installation notes. Otherwise failure-free and safe operation cannot be guaranteed. The EU declaration of conformity is available upon request from the following address:

Sophos Technology GmbH
Gustav-Stresemann-Ring 1
65189 Wiesbaden
Germany

Operating elements and connections

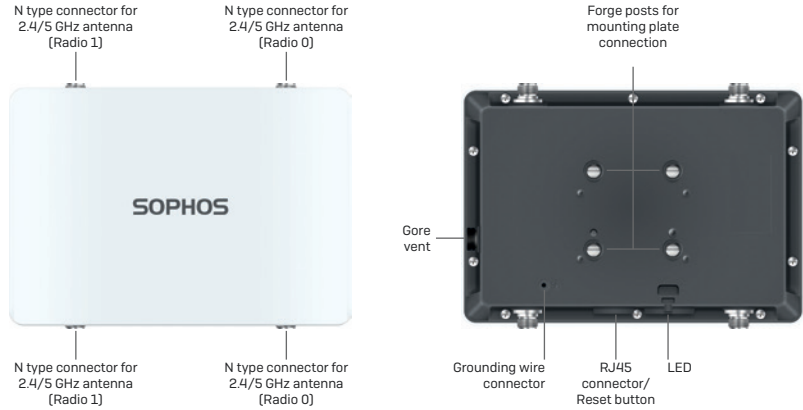

Component descriptions

Component	Description
Status LED	Indicates the operational state of your access point such as boot status, firmware updates and error states. For details, see table "LED Status" below.
Radio LED	Indicates the radio mode your access point is currently operating in. For details, see table "LED Status" below.
Mesh LED	Indicates whether the access point has Mesh activated.
RJ45 connector	Primary Ethernet port to connect your access point to your network. This port needs to be connected to a PoE capable source (PoE Injector or PoE switch) to power your access point. There is no dedicated DC power source available. Sophos offers suitable PoE injectors for purchase as an optional accessory.
Reset button	Allows you to reboot the device and reset its configuration to the factory default. For details, please see section "Reboot & Reset"
Gore Vent	Prevents excessive heat build-up inside the product while still preventing moisture entry
Grounding Wire Connector	Used for permanently connecting the APX to earth ground to adequately ground the chassis and protect the operator from electrical hazards.
N Type connector	Used for connecting the standard Omni- or optional Sector/Directional antennas
Forge posts	Used for connecting the mounting bracket.

LEDs

Status	Off	Off	AP is off or reboot started
	Green	Solid	Normal operation
		Flashing	AP is booting and connecting to wireless controller or applying configuration*
	Amber	Solid	AP has no connection to the wireless controller
		Flashing	AP is not claimed by wireless controller
	Red	Solid	Error, no wireless controller found. AP will reboot (if not yet claimed by a controller). Check network connection if error persists. If reset button pressed: AP preparing configuration reset
		Flashing slowly	Configuration reset in progress*
Flashing fast		Firmware update in progress Note: Do not disconnect from power, nor reboot or reset the device When the device connects to Sophos Central or Sophos Firewall for the first time, it might take more than 15 minutes to update firmware.	
Radio	Green	Solid	AP is operating in 2.4 and 5 GHz mode
	Amber	Solid	AP is operating in dual 5 GHz mode
	Red	Solid	AP is operating 1 Radio mode 2.4 OR 5 GHz
Mesh	Off	Off	No Mesh activated
	Green	Solid	Mesh activated

* Your AP should recover from this state after a maximum of 5 minutes.

Connection and configuration

Your access point can be managed by a wireless controller located in Sophos Central. The initial connection of your access point to your network and the wireless controller is described in the APX Quick Start Guide which was shipped with your device or is available under www.sophos.com/get-started-ap.

For the access point to communicate with Sophos Central servers the following ports will need to be open on your firewall:

- 443 [HTTPS]
- 80 [HTTP]
- 123 [NTP]

After successful connection you can start your initial configuration.

Setting up your access point in Sophos Central

You will need a Sophos Central account to manage your access points from Sophos Central. Please go to <https://central.sophos.com> to sign in under your account or create a new account.

After signing in select *Wireless* from the popup screen or click on *Wireless* in the left navigation to get started.

Follow the Onboarding *Wizard* to register your access point.

For more information, please see the [Sophos Central Admin Help](#).

Setting up your access point in XG Firewall

Please note: APX 320X is not supported on XG or XGS Firewalls.

Reboot and reset

Your access point can be rebooted with the installed configuration or reset to the factory default configuration depending on how long you press and hold the reset button.

Reboot with current image and configuration

1. Press reset button.
2. Release reset button.
3. AP reboots (LED will go off, then will turn to solid green).

Reboot with current image and clear configuration

1. Press and hold reset button.
2. AP reboots (LED will go off and then switch to green briefly).
3. LED will turn solid red for 5 sec. You can still cancel the configuration clearance process by releasing the reset button before the LED starts blinking.
4. LED will blink red (configuration will be cleared).
5. Release reset button.
6. AP reboots with factory default settings.

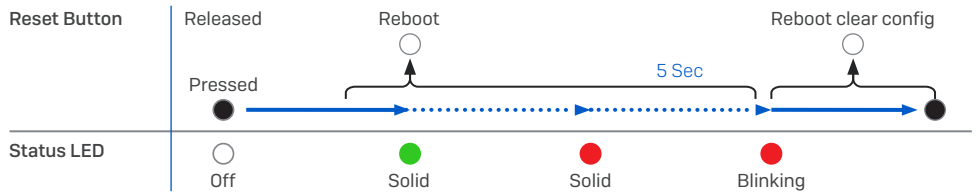

Technical specifications

APX 320X	
Environment	
Power consumption	18.9 W [max.]
Power over Ethernet (PoE) requirements	802.3at
Operating temperature	-40° to 55° C
Storage temperature	-40° to 80° C
Humidity	10-95% non-condensing
Hazardous substances	RoHS-2 and REACH compliant
Physical specification	
I/O ports	1x RJ45 10/100/1000 Ethernet w/PoE (802.3at) 1x Reset button
Memory	512 MByte DDR3L 512 Mbyte NAND Flash 16 Mbyte SPI NOR Flash
Mounting	Wall-mount hang Pole mount
Dimensions (Width x Depth x Height)	260.5 x 180 x 87 mm (10.26 x 7.09 x 3.43 inches)
Weight	1.42 kg (3.13 lbs)
Wireless specification	
Radios	1x 2.4 GHz/5 GHz dual-band 1x 5 GHz single band
Antennas	4x omni-directional external dual-band antennas for Radio-0 and Radio-1
Antenna Peak Gain	3.2 dBi at 2.4 GHz, 6.0 dBi at 5 GHz
MIMO capabilities	2x2:2
Supported WLAN standards	IEEE 802.11 a/b/g/n/ac Wave 2 (Wi-Fi 5)
SSIDs	8 per radio, 16 in total (with dual radios active)
Max. Throughput	Dual 5 GHz Mode*: up to 867 Mbps (5 GHz) + 867 Mbps (5 GHz) Dual-band Mode*: up to 300 Mbps (2.4 GHz) + 867 Mbps (5 GHz) Single 5 GHz Mode**: up to 867 Mbps

* Not available in the countries listed here: <https://support.sophos.com/support/s/article/KB-000039850>

** For the countries listed here: <https://support.sophos.com/support/s/article/KB-000039850>

Performance			
Band/Mode	Data Rate	TX Power Maximum EIRP [dBm]	RX Sensitivity [dBm]
2.412–2.472 GHz (11b)	1 Mbps	24	-93
	2 Mbps	24	-90
	5.5 Mbps	24	-86
	11 Mbps	24	-82
2.412–2.472 GHz (11g)	6 Mbps	24	-89
	9 Mbps	24	-88
	12 Mbps	23	-86
	18 Mbps	23	-84
	24 Mbps	22	-81
	36 Mbps	22	-77
	48 Mbps	21	-73
	54 Mbps	21	-72

Performance			
2.412–2.472 GHz (11n HT20)	MCS 0	24	-88
	MCS 1	24	-85
	MCS 2	23	-83
	MCS 3	23	-80
	MCS 4	22	-76
	MCS 5	22	-72
	MCS 6	21	-71
	MCS 7	21	-70
5.180–5.825 GHz (11a)	6 Mbps	26	-83
	9 Mbps	26	-82
	12 Mbps	25	-81
	18 Mbps	25	-77
	24 Mbps	24	-73
	36 Mbps	24	-69
	48 Mbps	23	-68
	54 Mbps	23	-66
5.180–5.825 GHz (11ac VHT20)	MCS0	26	-82
	MCS1	26	-78
	MCS2	25	-75
	MCS3	25	-74
	MCS4	24	-71
	MCS5	24	-67
	MCS6	23	-66
	MCS7	23	-65
5.180–5.825 GHz (11ac VHT40)	MCS0	26	-80
	MCS1	26	-76
	MCS2	25	-73
	MCS3	25	-72
	MCS4	24	-69
	MCS5	24	-65
	MCS6	23	-64
	MCS7	23	-63
	MCS8	22	-59
5.180–5.825 GHz (11ac VHT80)	MCS0	26	-76
	MCS1	26	-74
	MCS2	25	-71
	MCS3	25	-70
	MCS4	24	-67
	MCS5	24	-63
	MCS6	23	-62
	MCS7	23	-61
	MCS8	22	-56
MCS9	22	-54	

Radiation patterns

2.4 GHz Band

H-plane

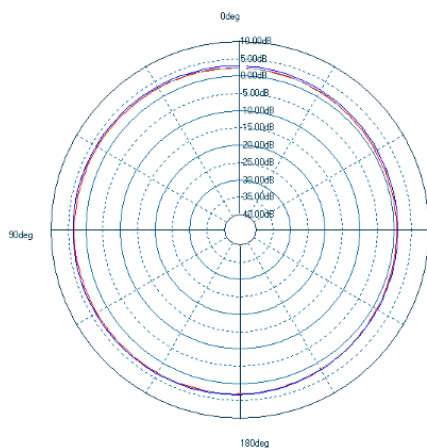

V-plane

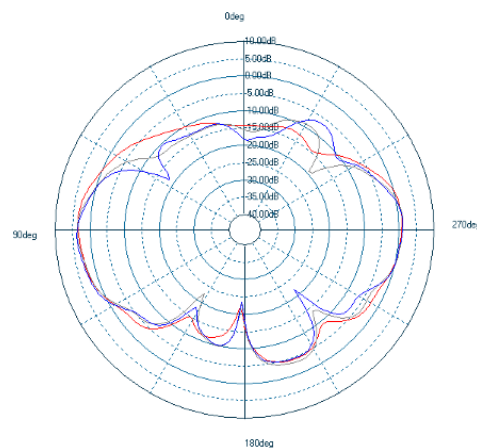

-2400 [MHz] -2450 [MHz] -2500 [MHz]

5 GHz Band

H-plane

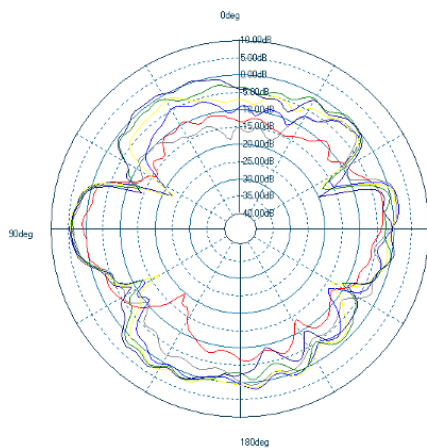

V-plane

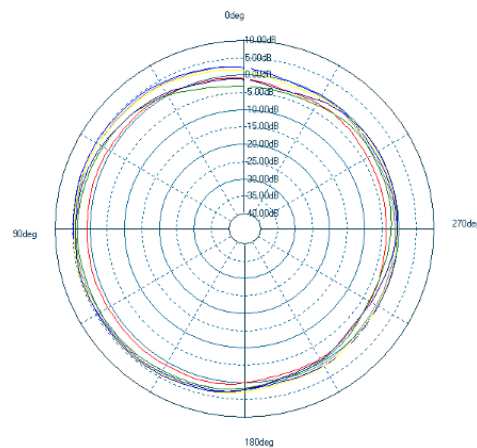

-4900 [MHz] -5150 [MHz] -5350 [MHz] -5475 [MHz] -5725 [MHz] -5875 [MHz]

Optional Sector / Directional Antennas



Technical specifications

Optional Sector / Directional Antennas		
120° Sector Antenna		
Frequency range	2400~2500 MHz	5150~5850 MHz
Port	V-pol. / H-pol.	V-pol. / H-pol.
Antenna Gain	10.6~10.8 dBi / 10.0~11.4 dBi	12.5~13.1 dBi / 11.6~12.9 dBi
HPBW / Horizontal	76~77 deg / 63~66 deg	40~61 deg / 52~76 deg
HPBW / Vertical	24~25 deg / 26~28 deg	11~13 deg / 11~13 deg
Isolation	20 dB	
Impedance	50 Ohms	
Connector	N Jack	
Dimensions (Height x Width x Depth)	320 x 200 x 20.5 mm [12.6 x 7.87 x 0.81 inches]	
30° Directional Antenna		
Frequency range	2400~2500 MHz	5150~5850 MHz
Port	V-pol. / H-pol.	V-pol. / H-pol.
Antenna Gain	11.6~11.8 dBi / 11.6~12.0 dBi	10.6~11.0 dBi / 10.4~11.5 dBi
HPBW / Horizontal	36~37 deg / 35~36 deg	33~35 deg / 26~36 deg
HPBW / Vertical	34~35 deg / 36~38 deg	32~39 deg / 30~41 deg
Isolation	20 dB	
Impedance	50 Ohms	
Connector	N Jack	
Dimensions (Height x Width x Depth)	320 x 200 x 20.5 mm [12.6 x 7.87 x 0.81 inches]	

Radiation patterns Sector Antenna – Horizontal Polarization 2.4 GHz Band

H-plane

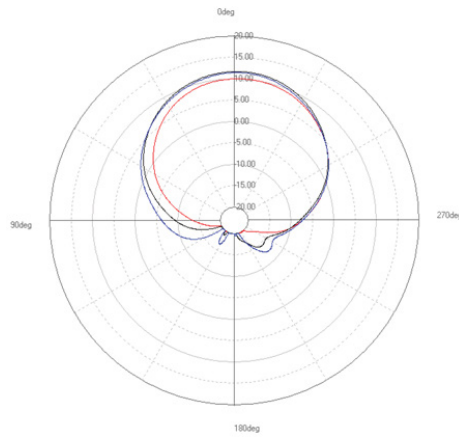

V-plane

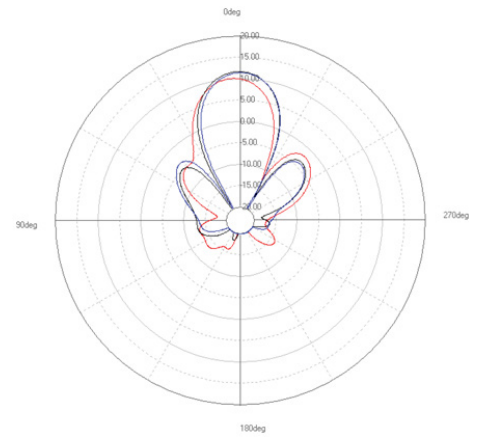

—2400 [MHz] —2450 [MHz] —2500 [MHz]

5 GHz Band

H-plane

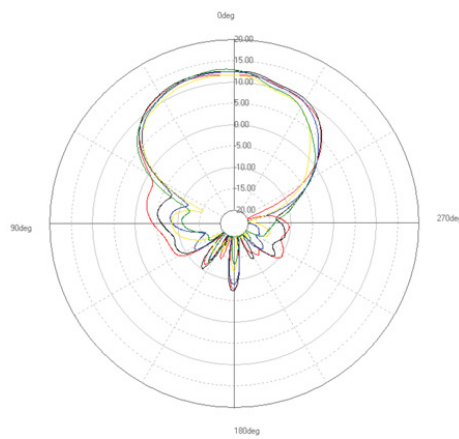

V-plane

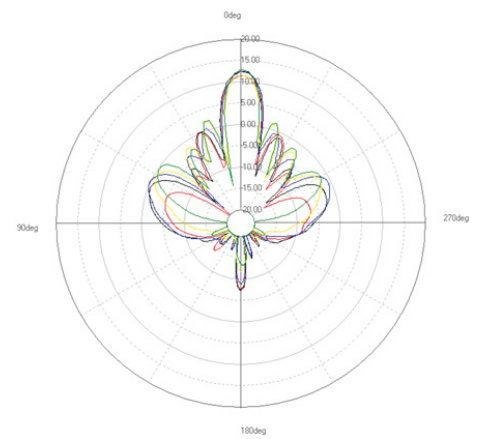

—4900 [MHz] —5150 [MHz] —5350 [MHz] —5475 [MHz] —5725 [MHz] —5875 [MHz]

Radiation patterns Sector Antenna – Vertical Polarization 2.4 GHz Band

H-plane

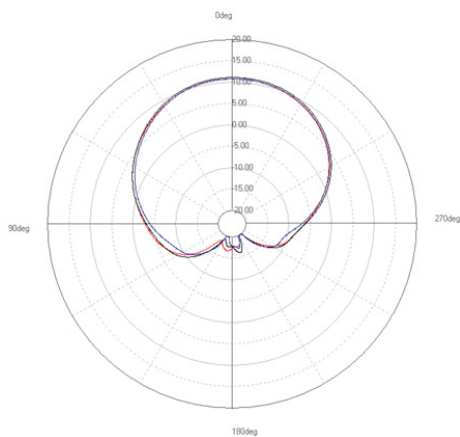

V-plane

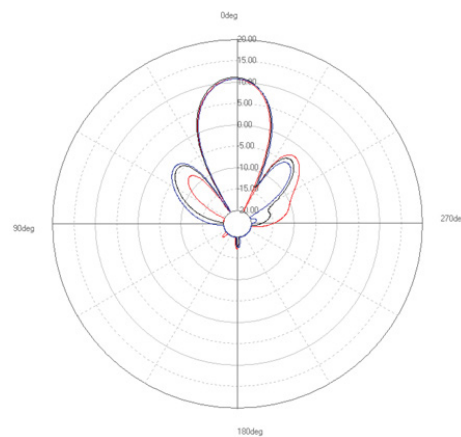

—2400 [MHz] —2450 [MHz] —2500 [MHz]

5 GHz Band

H-plane

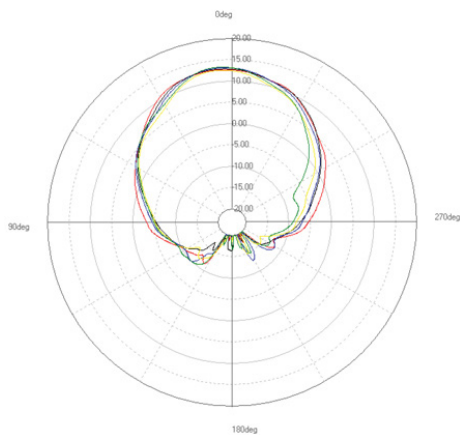

V-plane

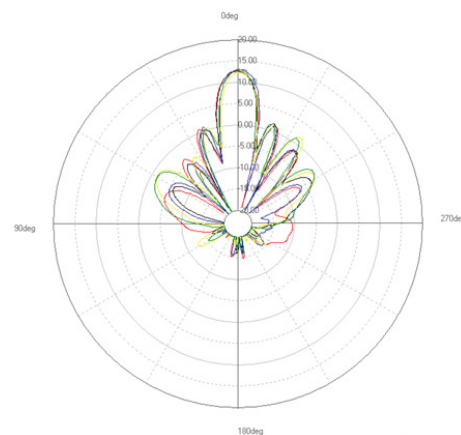

—4900 [MHz] —5150 [MHz] —5350 [MHz] —5475 [MHz] —5725 [MHz] —5875 [MHz]

Radiation patterns Directional Antenna – Horizontal Polarization

2.4 GHz Band

H-plane

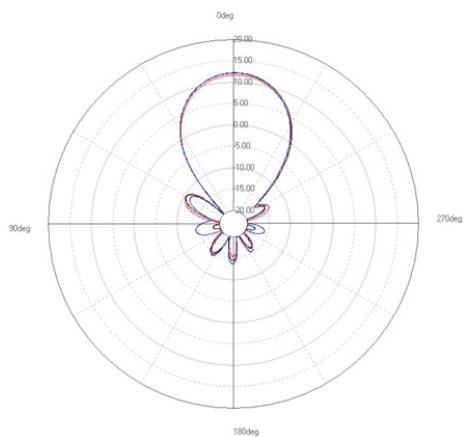

V-plane

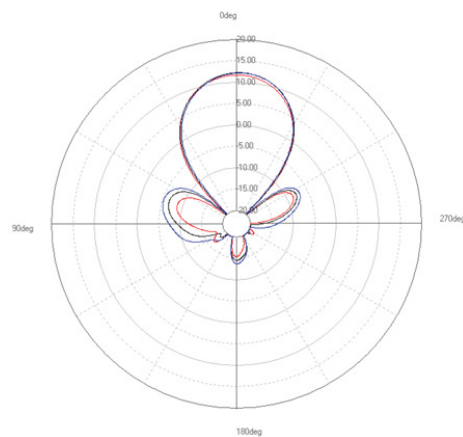

—2400 [MHz] —2450 [MHz] —2500 [MHz]

5 GHz Band

H-plane

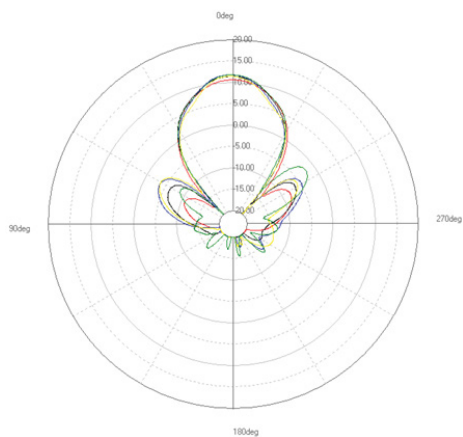

V-plane

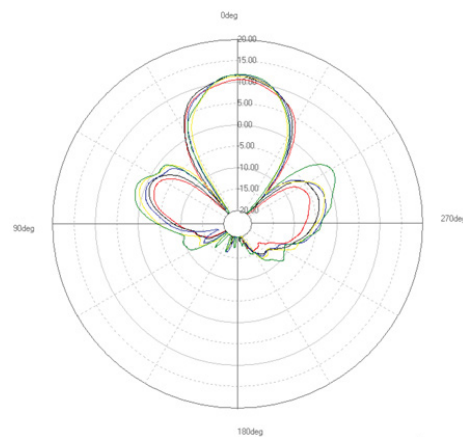

—4900 [MHz] —5150 [MHz] —5350 [MHz] —5475 [MHz] —5725 [MHz] —5875 [MHz]

Radiation patterns Directional Antenna – Vertical Polarization

2.4 GHz Band

H-plane

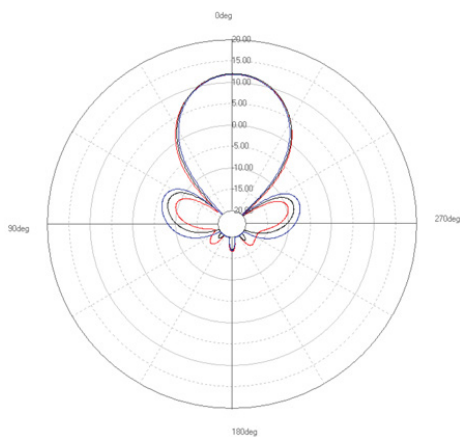

V-plane

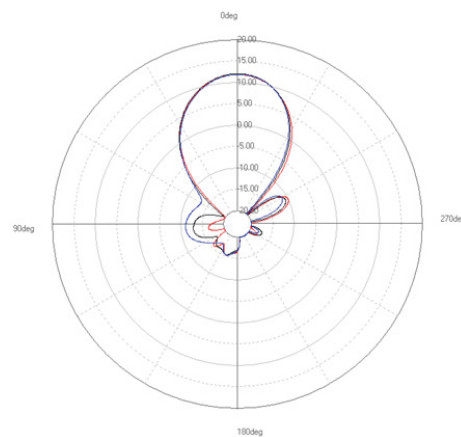

—2400 [MHz] —2450 [MHz] —2500 [MHz]

5 GHz Band

H-plane

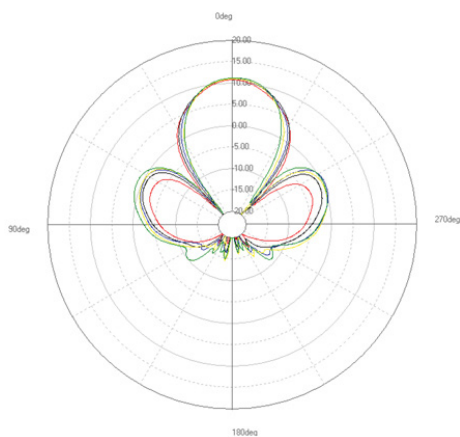

V-plane

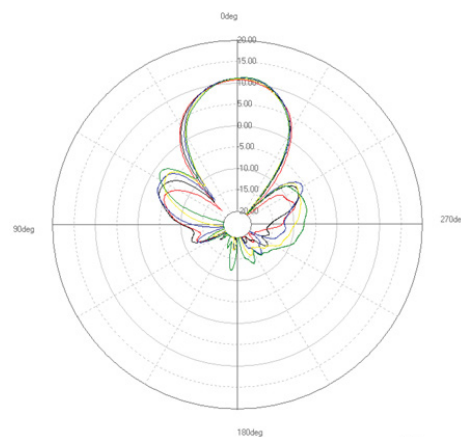

—4900 [MHz] —5150 [MHz] —5350 [MHz] —5475 [MHz] —5725 [MHz] —5875 [MHz]

Mounting instructions

There are various mounting options available allowing you to hang your access point on the wall or mount it on a pole. Both options require the use of the mounting bracket which is shipped with your access point. The following sections provide detailed instructions on each of these options.

Mounting bracket

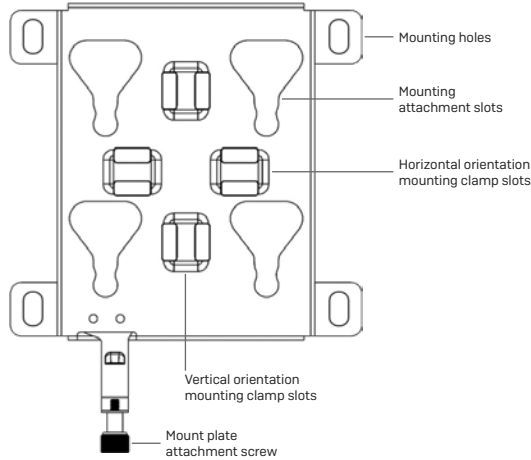

Wall mount

1. Use the mounting bracket to mark the screw mounting positions on the wall.
2. Attach the access point to the bracket by hanging the 4 forge posts into the attachment slots of the bracket and pressing it down.
3. Tighten the attachment screw to fix the access point to the bracket.

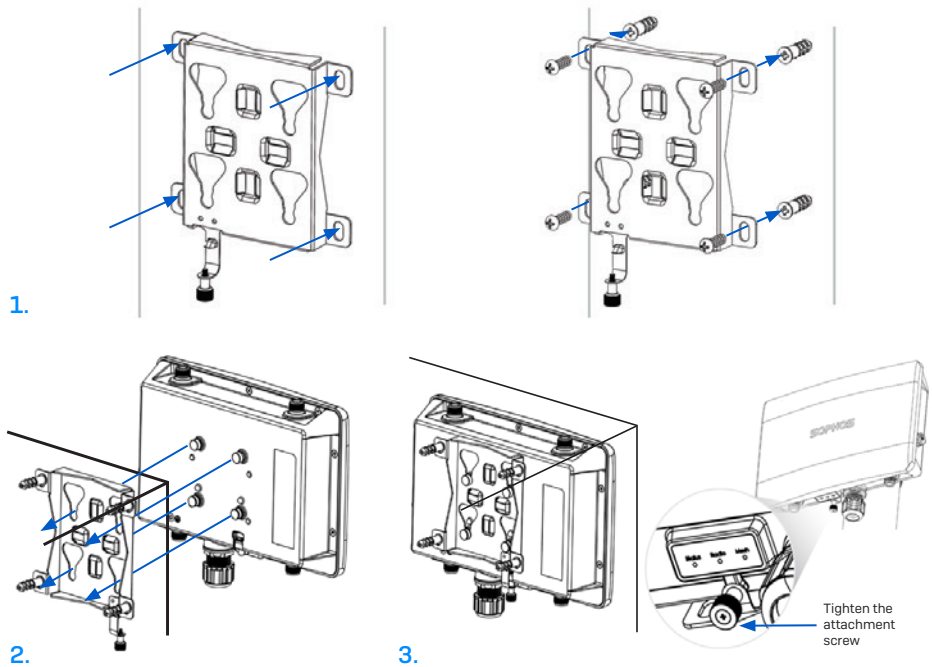

Pole mount

1. Attach the two metal clamps to the back of the mounting bracket using the vertical or horizontal mounting slots (according to the desired orientation).
2. Hold the bracket against the pole and tighten the metal clamps.
3. Attach the access point to the bracket by hanging the 4 forge posts into the attachment slots of the bracket and pressing it down.
4. Tighten the attachment screw to fix the access point to the bracket

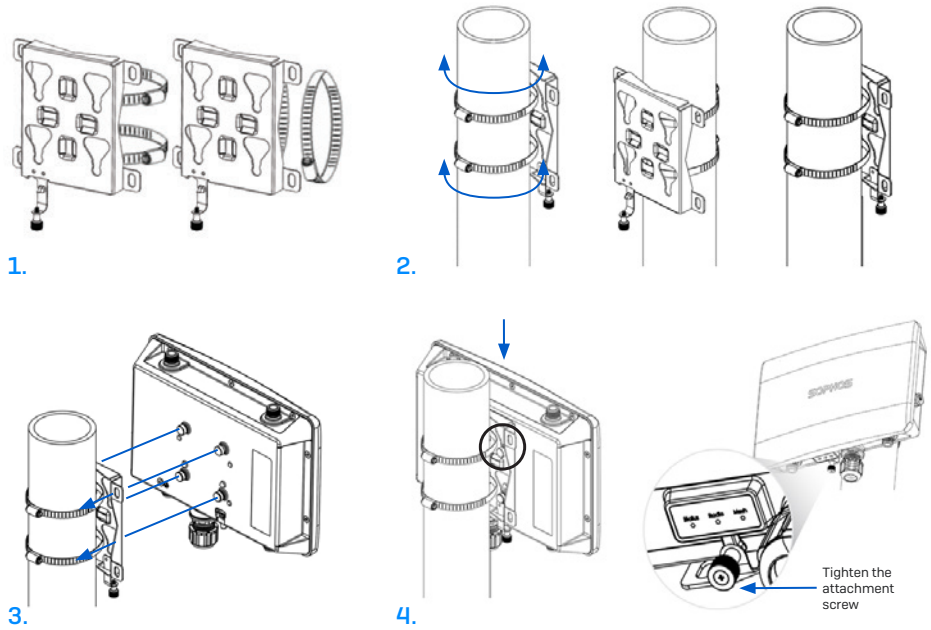

Sector / Directional Antenna Mounting Instructions

1. Attach the articulating mount to the back of the Sector / Directional antenna using four of the supplied M6 nuts.
2. Fix the T-form bracket to the pole by using the two supplied stainless steel hose clamps.
Please note: The clamps can be used for poles of 35-80 mm (1.5-3 inches) diameter.
3. Fix the articulating mount to the T-form bracket by using the supplied M8x40 bolts, nut, spring washer and washer.
4. Direct the antenna upward or downward (max. angle is 27°) and fix it into place.

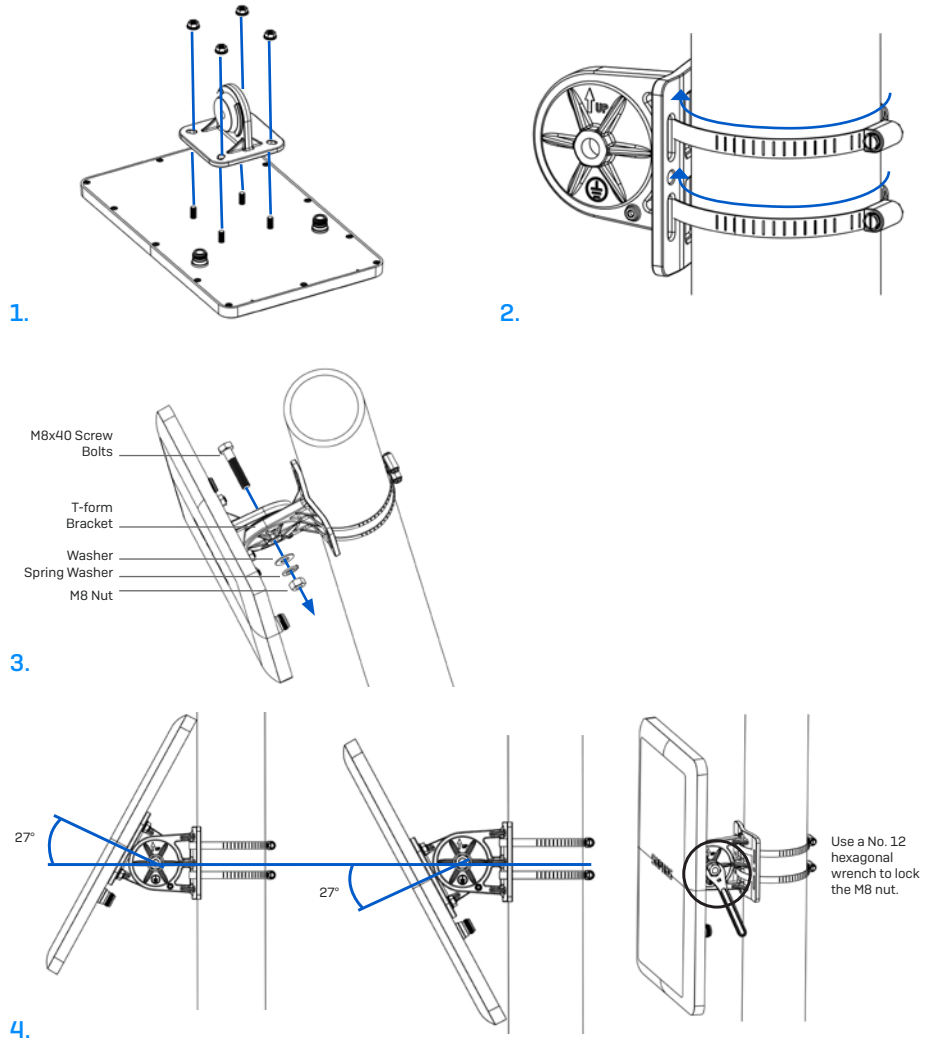

Connect the Sector / Directional Antenna to the Access Point

Connect the antenna to your APX 320X access point by using the supplied cables. You can use your sector/directional antenna either in combination with the standard omni-directional antennas or with another sector/ directional antenna.

Choose the appropriate connection for the scenario which best fits your use case - as shown in the table below.

Scenario	Radio 0 [2.4/5 GHz High Band]	Radio 1 [5 GHz Low Band]
a	Sector/Directional (Top/Bottom)	Sector/Directional (Top/Bottom)
b	Sector/Directional (Top/Bottom)	Omni (Top/Bottom)
c	Omni (Top/Bottom)	Sector/Directional (Top/Bottom)

NOTE: If you use the sector/directional antenna with the APX 320X in some countries, the use of Radio-1 may not be possible. Regulatory restrictions in some countries prohibit the use of low band 5 GHz channels which do not support DFS in outdoor environments. Therefore, Radio-1 cannot be configured when used in the countries listed here: <https://support.sophos.com/support/s/article/KB-000039850>. In those countries, this model will function as a single radio device [2.4 OR 5 GHz], your antennas should be connected to Radio-0 only, and concurrent use of the sector/directional and omni-directional antennas is not possible.

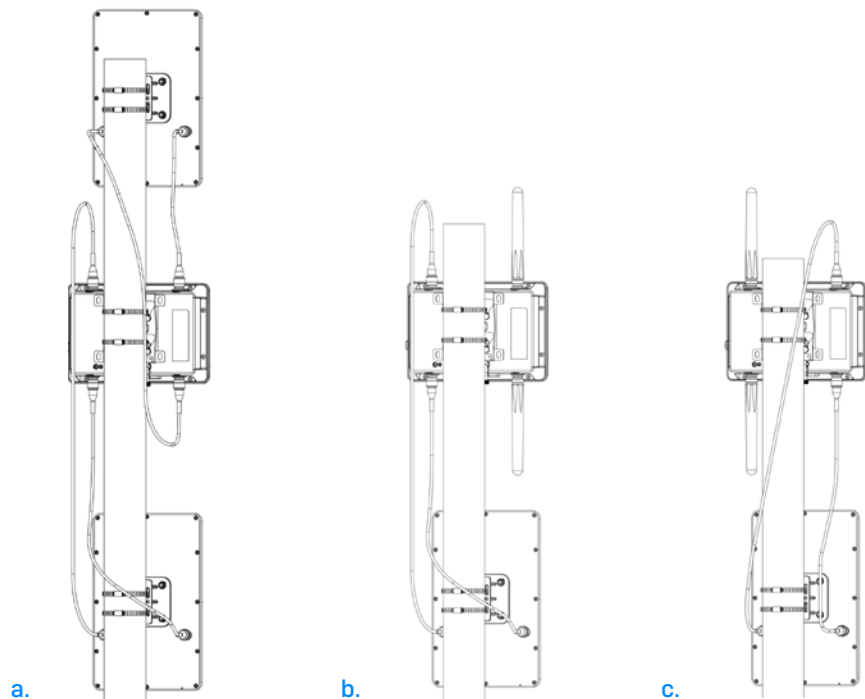

Configure Sector / Directional Antenna Software Settings

Once the external antenna is connected, please select the corresponding antenna settings in your Sophos Central Wireless admin account. Once selected and the configuration synched, the AP reboots and the correct power values will be set.



WARNING: Failure to configure the correct antenna settings may place the AP outside of regulatory limits. The administrator is responsible for ensuring this configuration is correct.

United Kingdom and Worldwide Sales
Tel: +44 (0)8447 671131
Email: sales@sophos.com

North American Sales
Toll Free: 1-866-866-2802
Email: nasales@sophos.com

Australia and New Zealand Sales
Tel: +61 2 9409 9100
Email: sales@sophos.com.au

Asia Sales
Tel: +65 62244168
Email: salesasia@sophos.com